

**NuTone**  
**STANDARD**  
**SECURICOM**  
IMA-226

**Home Owner's**  
**Operating**  
**Manual**

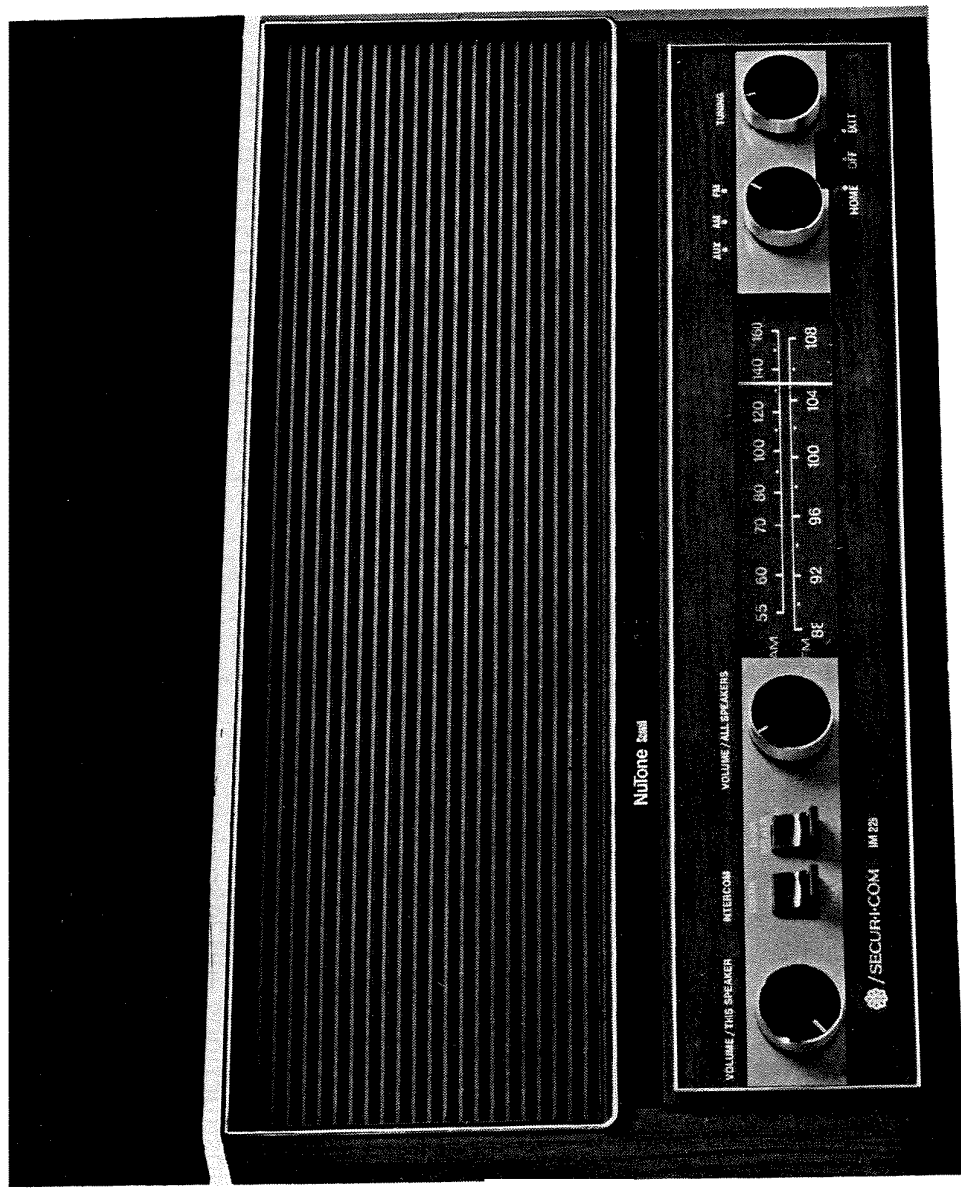

**IMPORTANT:**

Hang this booklet on front of the NuTone Security/Radio-Intercom. It contains **important information** necessary for proper operation of this system.

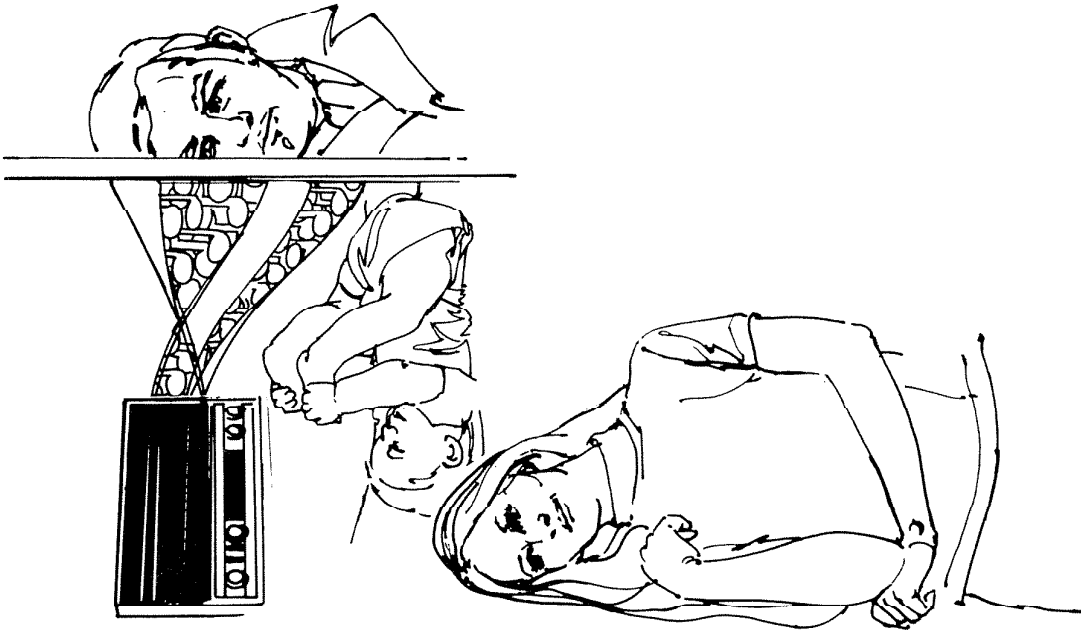

## YOUR FUTURE WITH NuTone

A Securicom like the IMA-226 means more than luxury to you and your household. It means pleasure from an AM/FM Radio with . . . advanced solid-state design, a slide-rule station indicator, and automatic AFC to give you improved performance.

And convenience — a built-in Door Signal to announce callers, and door answering and room-to-room Intercom from any Remote Station. But the most unique feature that your Securicom can offer you is SECURITY! An intruder detection circuit with 3 settings for on, off, and a special time/delay setting for exiting and entering your home without sounding the alarm. The alarm in the Master Station will provide a penetrating sound if entry is attempted . . . whether you're at home or away.

And for more security, you'll be able to listen-in to different stations and know first hand what is occurring throughout your home . . . even at night, while you sleep, your Intercom System can keep an "ear" on things and notify you of any disturbing noises inside or outside your home. Just take a few minutes now to follow the easy to understand step-by-step instructions and learn how to make this precision instrument work for you and benefit your household. Then sit back and be assured years of sound pleasure from the finest Securicom anywhere.

# CONTENTS

ENTIRE SYSTEM		
Picture of Master .....	4	
Description of Controls on Master .....	5	
Setting Volume of Entire System .....	6	
Individual Station Controls .....	7	
RADIO		
How to Operate Radio .....	8	
INTERCOM		
Talking from the Master to all other Stations .....	9	
Making Calls from any Remote Station .....	10	
How to Answer your Door .....	11	
Listening-in to One or More Rooms .....	12	
SECURITY		
How to Operate your Security System .....	13 & 14	
ACCESSORIES .....		15
CONNECTING A PHONO OR TAPE PLAYER .....	16	
HOW TO REMOVE MASTER UNIT .....	17	
HOW TO ADJUST INTERCOM VOLUME .....	18	
HELPFUL HINTS .....	(inside back cover)	
FOR SERVICE OR SALES .....	(back cover)	

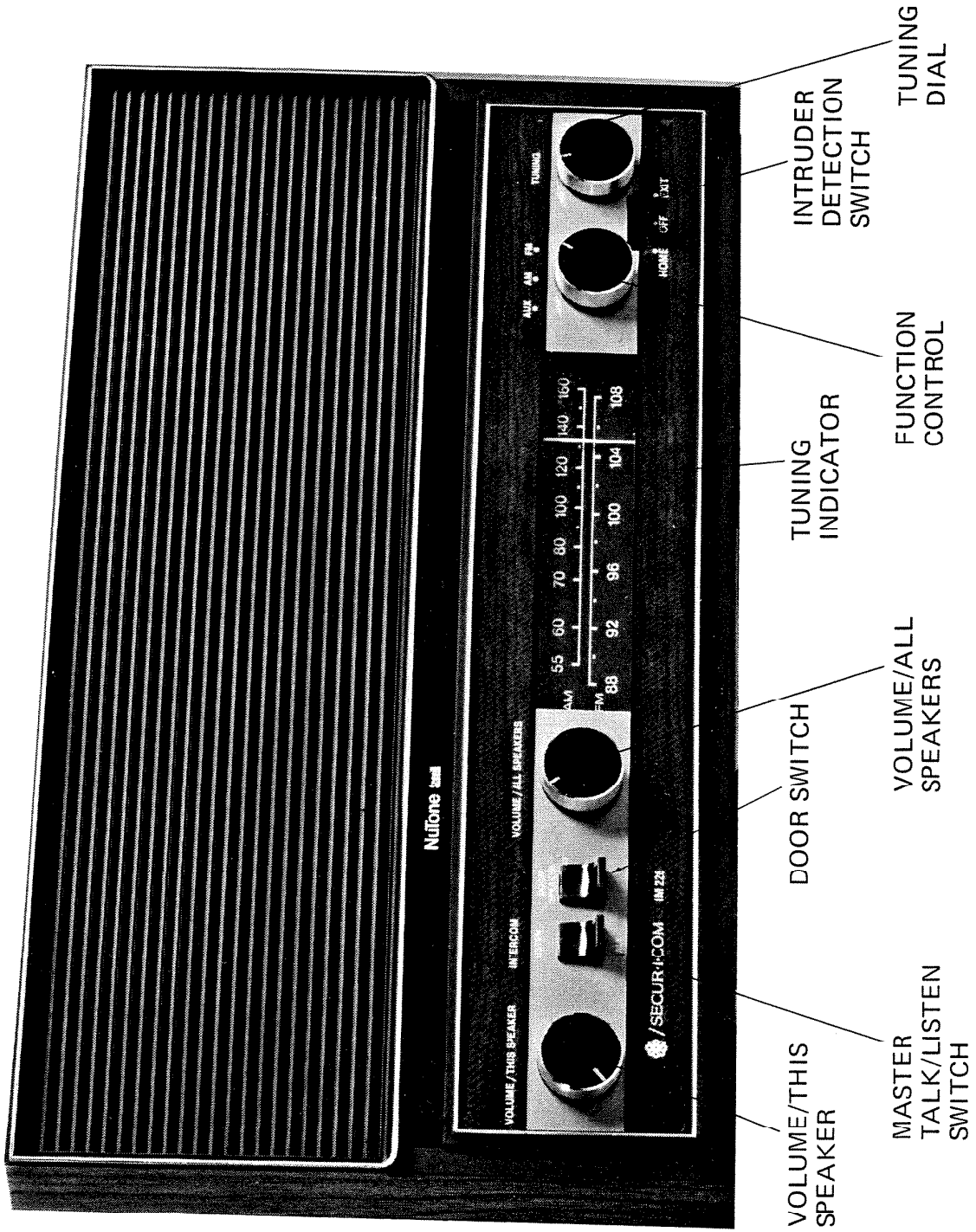

## **DESCRIPTION OF CONTROLS ON MASTER**

### **Volume/This Speaker**

Use this knob to control only the volume of the Master Station Speaker. This knob does not affect the volume of the Remote Stations. When speaking from the Master, have this knob at maximum.

### **Master Talk/Listen Switch**

Communicate throughout your home with a flip of this switch on the Master Station.

### **Door Switch**

Lets you answer your front door without opening it up. A great security feature you'll certainly appreciate.

### **Volume/All Speakers**

Use this control to turn the Radio & Intercom ON and OFF, and to set the volume for the entire system. (Security System & Door Signal are operational at all times.)

### **Tuning Indicator**

Find the station you want easily . . . AM stations on the upper scale; FM stations on the lower scale.

### **Function Control**

Choose AM or AM Radio with this switch . . . or switch the control to Auxiliary (AUX) and have the convenience of Intercom without Radio. This position is also used to select the Phono or 8-Track Tape function when the accessory is a part of your Intercom System.

### **Intruder Detection Switch (Home/Off/Exit)**

Use this switch to control the Security Alarm System. HOME position activates the detection circuitry. In this position, the system will sound the alarm the instant the system detects forced entry. OFF position turns off the system. EXIT position provides a special time/delay feature to permit you to leave and re-enter your home without sounding the alarm.

### **Radio Tuning Knob**

Choose your favorite radio station with the help of this knob and the slide rule indicator.

## ENTIRE SYSTEM

### SETTING THE VOLUME OF THE ENTIRE SYSTEM

1. Go to each Remote Station and turn the VOLUME control to the complete clockwise position (maximum volume).
2. Return to the Master Station and turn the VOLUME/ALL SPEAKERS approximately 1/3 clockwise from the OFF position. Tune in your favorite radio station.
3. Now, adjust the VOLUME/ALL SPEAKERS control until you have enough volume at the Remote Station requiring the high test volume (such as a large living room or family room).
4. Go to each Remote Station and adjust the VOLUME control for the desired sound level.



Master

#### NOTE:

Always remember . . . the control knob on the Master Station marked VOLUME/ALL SPEAKERS must be turned ON to operate your Intercom and Radio.

#### CAUTION:

If the VOLUME controls on the Remote Stations are turned too low and the VOLUME/ALL SPEAKERS control on the Master Station is too high, distortion may result.

# ENTIRE SYSTEM

## INDIVIDUAL STATION VOLUME CONTROL

All the Speakers (except the Door Speaker) have their own VOLUME controls. This makes it easy for everyone at individual Stations to select the volume they want. And if someone doesn't want to be disturbed, he may set the VOLUME control to the full counterclockwise setting and have Privacy.

1. Master Station — Turn the VOLUME/THIS SPEAKER counterclockwise to make sounds softer and clockwise to make sounds louder. A complete counterclockwise setting will turn the Master Station Speaker OFF for Privacy.
2. Remote Stations — Turn the VOLUME control knob counterclockwise to make it softer and clockwise to make it louder. Maximum counterclockwise setting will turn the Station OFF for Privacy.

### NOTE:

No individual Station VOLUME control can increase the volume greater than the volume level set by the VOLUME/ALL SPEAKERS control knob on the Master Station.

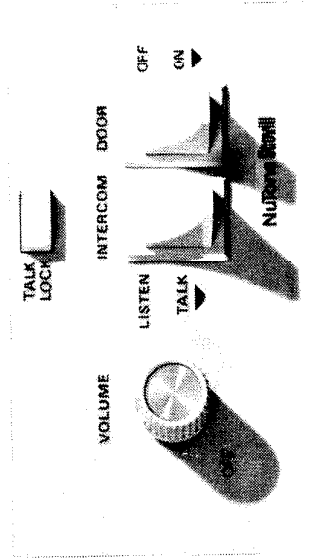

Remote Speaker Controls

# RADIO TUNING IN

8

1. First, turn the **VOLUME/ALL SPEAKERS** knob ON and make sure the volume is loud enough.
2. Switch your **Function Control** knob at **AM** or **FM**.
3. Next, select the station you want. Use the bottom scale for **FM** stations; the top scale for **AM**.
4. Adjust the volume for the entire system with the **VOLUME/ALL SPEAKERS** knob at the **Master Station**. No **Remote Station VOLUME** control can increase the volume set at the **Master Station**.

## IMPORTANT:

Keep the **Remote Station VOLUME** controls at maximum and adjust the **VOLUME/ALL SPEAKERS** control for the desired volume level. If **Remote Station VOLUME** controls are turned too low, and the **VOLUME/ALL SPEAKERS** control on the **Master** is tuned too high, distortion will result.

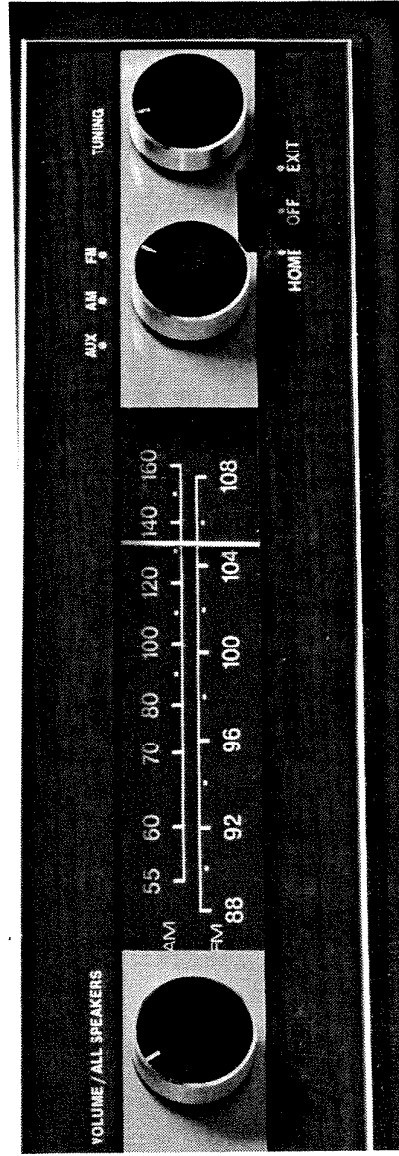

Master



# INTERCOM

TALKING FROM THE MASTER  
TO ALL OTHER STATIONS

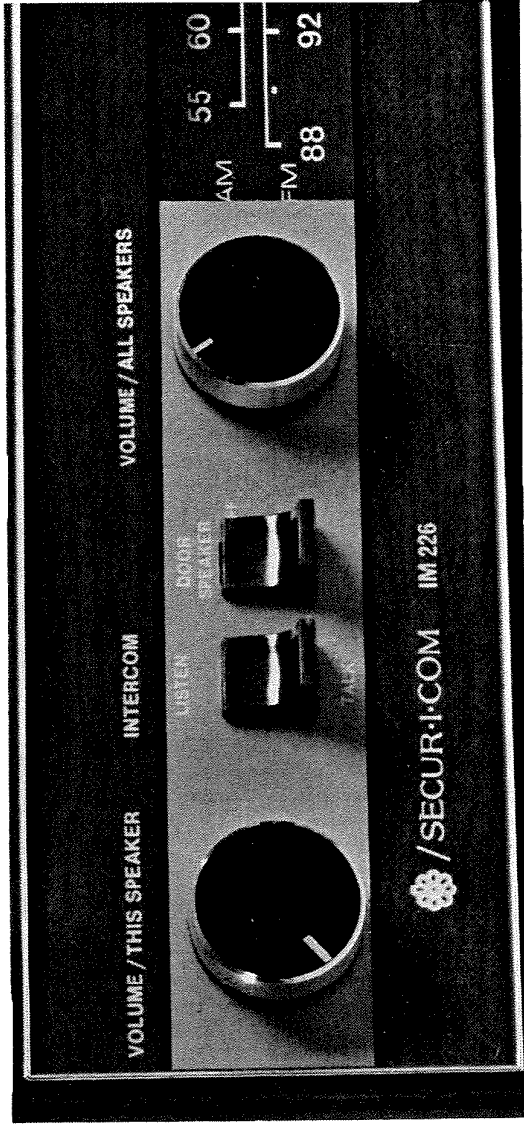

Master

1. Be sure the power (VOLUME/ALL SPEAKERS) control is turned on for entire system and volume is loud enough.
2. Turn the VOLUME/THIS SPEAKER control to maximum clockwise position.
3. TO TALK – push the TALK/LISTEN switch on Master unit to the down position and hold while talking. (Radio will be silenced.)
4. TO LISTEN – release the TALK/LISTEN switch and it will spring back to the LISTEN position. Persons at Remote Stations can reply by pushing their TALK/LISTEN button to the TALK position.

# INTERCOM

## HOW TO ANSWER YOUR DOOR WITH YOUR NEW INTERCOM

**Safety and Convenience** — you'll never have to open your door to strangers again; you'll save lots of time and extra steps.

**IMPORTANT:**

To answer the door, you must hold the Door Switch at the Station from which you are answering in the ON position.

1. **TO TALK** — with the Door Switch in the ON position, push the TALK/LISTEN switch down to the TALK position and hold while speaking.
2. **TO LISTEN** — with the Door Switch in the ON position, release the TALK/LISTEN switch.

**NOTE:**

While you are holding the Door Switch down in the ON position, callers at your door can speak without operating any controls.

3. **When the conversation is over, release the Door Switch.**

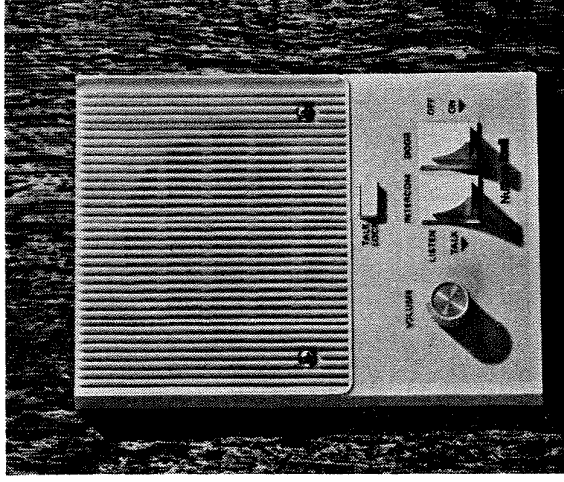

Remote Station

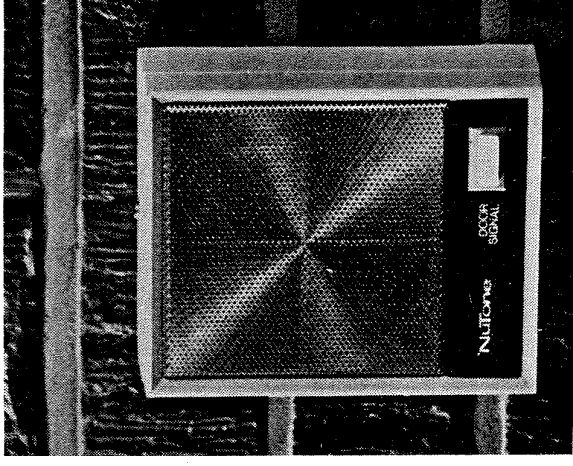

Door Speaker

# INTERCOM

## HOW TO MAKE CALLS FROM REMOTE STATIONS

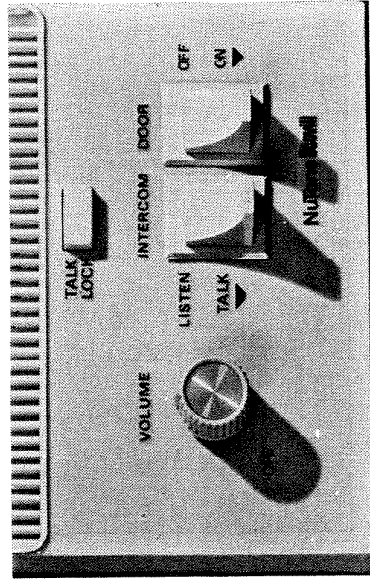

Remote Speaker

You can make calls from any Remote Station at any time, as long as the Radio Intercom is turned ON (VOLUME/ALL SPEAKERS).

Since your NuTone Securicom is fully transistorized and when left ON, ready for use, uses only a little more electricity than an electric clock . . . it's desirable to leave your unit on all the time.

1. Turn the Station VOLUME control to the maximum clockwise position.
2. TO TALK – push the TALK/LISTEN button down to the TALK position and hold while speaking.
3. TO LISTEN – release the TALK/LISTEN button and it will spring back to the LISTEN position.

### NOTE:

The Radio or auxiliary music is automatically silenced when you are having an Intercom conversation.

# INTERCOM

## HOW TO LISTEN-IN TO ONE OR MORE ROOMS

The ideal feature for keeping an "ear" on the children's rooms or a "sick-room". 12

1. For Remote Stations you want to listen-in on, turn their VOLUME controls to the maximum clockwise position.
2. Push the INTERCOM switch down to the TALK position and hold. Then, push the TALK LOCK button IN to lock the INTERCOM switch in the TALK position.
3. When you no longer want the Station set for "Listen-in," push the INTERCOM switch down and release sharply. It will automatically unlock and return to the LISTEN position.

The Remote Stations set for listening-in will transmit sounds to all other Stations not set for listening-in. Radio and auxiliary music will be silenced.

For added security during the night, listen-in to your entire home from your bedroom and be able to hear any disturbing noises. Just set the Stations throughout your home for listening-in and let your bedroom Station's TALK/LISTEN switch rest in the LISTEN position. YOUR PRIVATE NIGHT WATCHMAN!

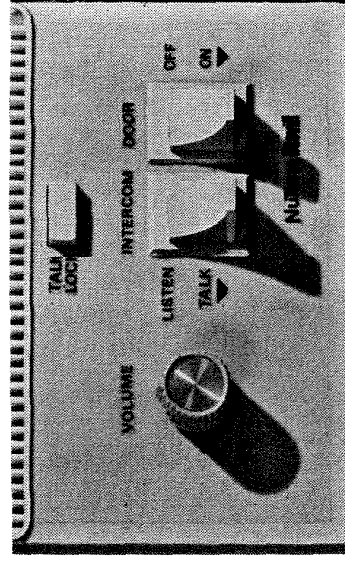

Remote Speaker controls

# SECURITY

## HOW TO OPERATE YOUR SECURITY SYSTEM

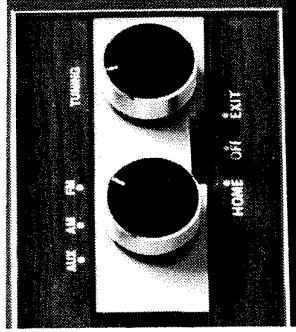

**WHEN YOU ARE AT HOME:** (Use this procedure also to test alarm)

1. Close all protected doors and windows.
2. Set Intruder Detection switch to the HOME position.
3. Forced entry through any protected door or window will sound an instant alarm.

**NOTE:**

The alarm will sound at the Master Station and the Door Speaker even when the Radio Intercom is turned off. If the Radio Intercom is turned on and the volume is set reasonably high, the alarm will sound throughout the Remote Speakers.

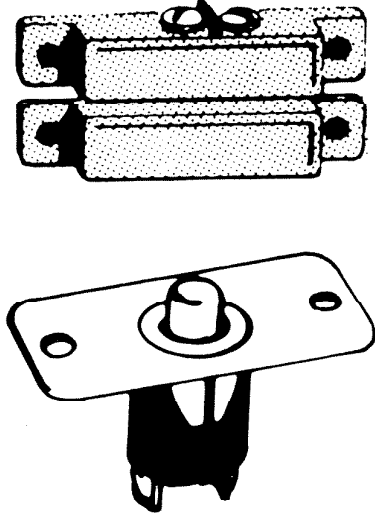

4. To silence the alarm, place the Intruder Detection switch in the OFF position.
5. To reactivate the Security System, close all protected doors and windows and set the Intruder Detection switch in the HOME position.

**NOTE:**

To open individual protected windows or doors for ventilation or access without sounding the alarm, set the optional shunt switches at each entry location to the ON position. If shunt switches are not provided, set the Intruder Detection switch on the Master to the OFF position.

# SECURITY

## HOW TO OPERATE YOUR SECURITY SYSTEM

### WHEN YOU LEAVE HOME:

A special Time/Delay feature has been built-in to your Security System to allow you to exit and re-enter without sounding the alarm.

1. Close all protected windows and doors. Test your System by placing the Intruder Detection switch in the HOME, then OFF position.
2. Now, set the Intruder Detection switch to the EXIT position. The alarm circuit is by-passed approximately 25 seconds to allow you to leave your home.

### NOTE:

If you do not leave within 25 seconds, set the Intruder Detection switch to the OFF position and repeat the procedure from step 1.

3. When you re-enter your home, close the protected door and set the Intruder Detection switch to the OFF position within 25 seconds to prevent sounding the alarm.
4. Follow the procedure outlined for "WHEN YOU ARE AT HOME" under SECURITY – Page 13.

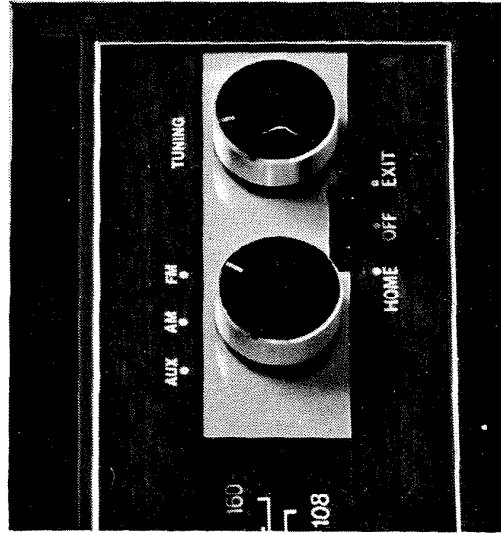

Master

## OPTIONAL ACCESSORIES

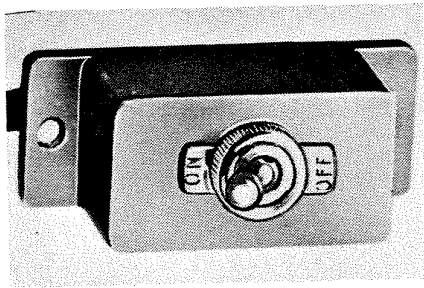

For a security convenience, NuTone offers this surface mounted ON-OFF shunt switch (Model S-2285). It installs along side windows and doors for ON-OFF control of individual protected areas.

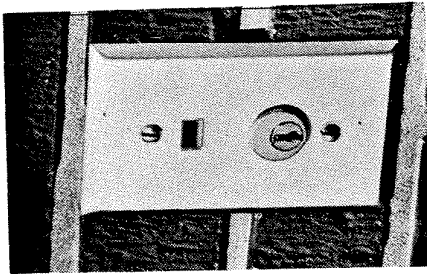

Another accessory for your Security System. An Exit/Entry Control Kit with a key operated ON-OFF switch for your entrances.

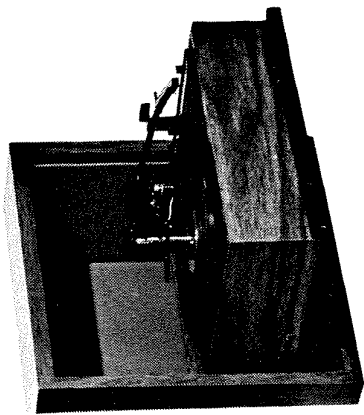
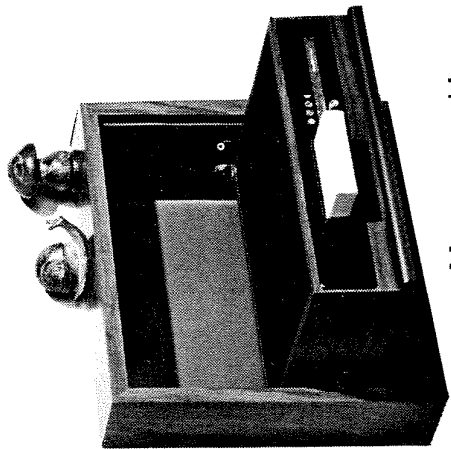

More sound in your future with NuTone . . . Have the advantages of a popular music source. Plus the convenience of having a unit that tilts out for use and back to store. NuTone's Record Changer (Model N-2603) or 8-Track Tape Player (Model N-2605) can easily be added to your NuTone Radio Intercom Master Station.

For additional information about accessories, write NuTone — Division of Scovill Consumer Relations Dept. Madison & Red Bank Rds. Cincinnati, Ohio 45227 or dial NuTone for the name of the dealer nearest you: 800-543-8687

# CONNECTION OF PHONO OR TAPE PLAYER TO MASTER STATION

An input jack is provided on the Master Station chassis for connecting a Phono or Tape Player to your System. The input jack in its present position is mounted for connecting a built-in Phono or Tape Player like NuTone's Model N-2603 Record Changer or Model N-2605 8-Track Tape Player.

To connect your own Phono or Tape Player follow the procedure outlined below.

1. First, remove Master Station from its housing. Refer to "HOW TO REMOVE MASTER STATION FOR SERVICE."
2. Next, remove the control knobs from the front of the Master. Pull each straight out, away from the unit.
3. Remove the 6 screws "A" from the chassis upon which the input jack is located.
4. Now, remove the 2 screws "B" from the input jack itself. Discard the metal strip holding the input jack wires.
5. Tilt the chassis up as shown in the illustration and reposition the input jack to the new location to enable you to connect your own Record Changer or Tape Player.

## NOTE:

Be careful not to let any wires come between the Tuning Dial Indicator and the Radio window on the underside of the board.

6. Place the chassis back to its original position. Replace screws "A."
7. Replace Master Unit into its housing, making all the proper wire connections.

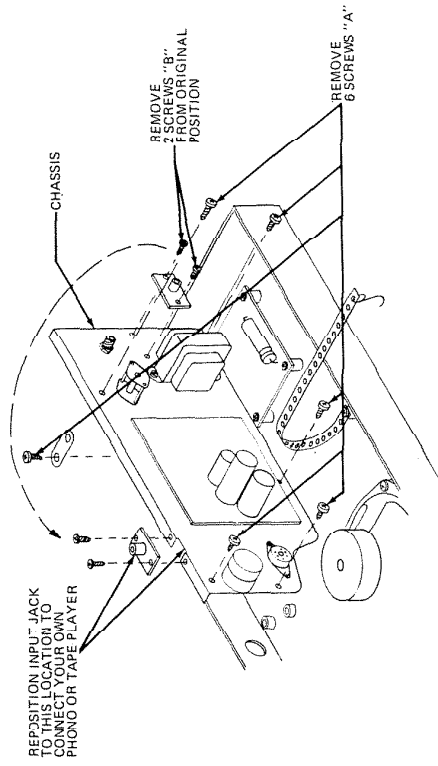



## HOW TO REMOVE MASTER STATION FOR SERVICE

Your NuTone Master Station has been designed for easy removal should service be required. To remove Master Station, follow the procedure outlined below.

1. Turn VOLUME/ALL SPEAKERS control knob fully counterclockwise to turn power OFF.
2. Remove Locking Pin from top center of Master Unit panel to release the unit from its housing. The Master Unit will drop forward.
3. Disconnect the low voltage power leads from the power source by removing the wire connectors. Replace connectors on power cables.
4. Remove Inside and Door Speaker wiring and Door Signal wiring from the PC boards at the left of the Master Unit. Remove antenna leads from the terminal strip in the upper right corner of housing. Disconnect ground wire from underneath hinge assembly.
5. With Master Unit open, and resting perpendicular to wall, grasp it firmly and lift straight up to remove the unit from the hinge pins.
6. Unhook nylon strap from top of Master Housing. Be sure to connect nylon support strap when re-installing the Master Unit.

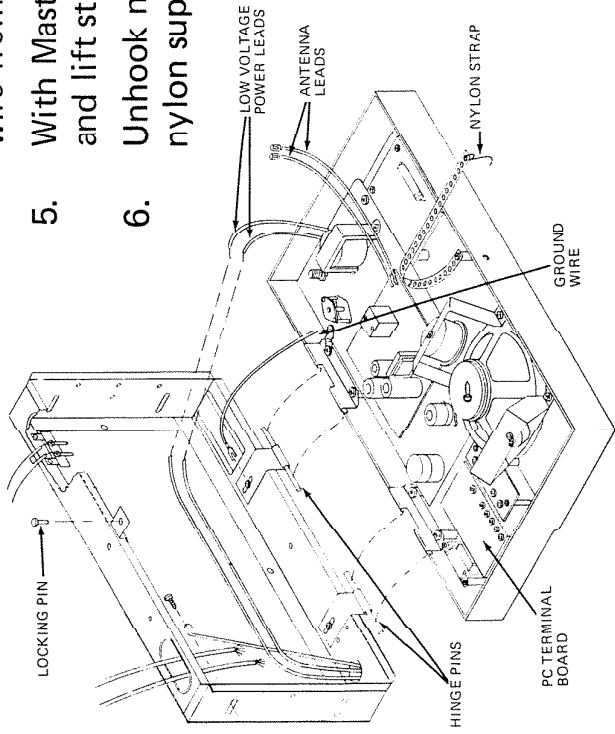

## HOW TO ADJUST INTERCOM VOLUME CONTROL

18

If your voice is not heard clearly over your Intercom System, you may adjust the Volume Control of your Intercom internally.

Before you attempt to do so, make sure you have carefully followed the instructions for operating the Intercom.

If you have followed the instructions carefully and your voice is still not heard clearly, follow the instructions outlined below.

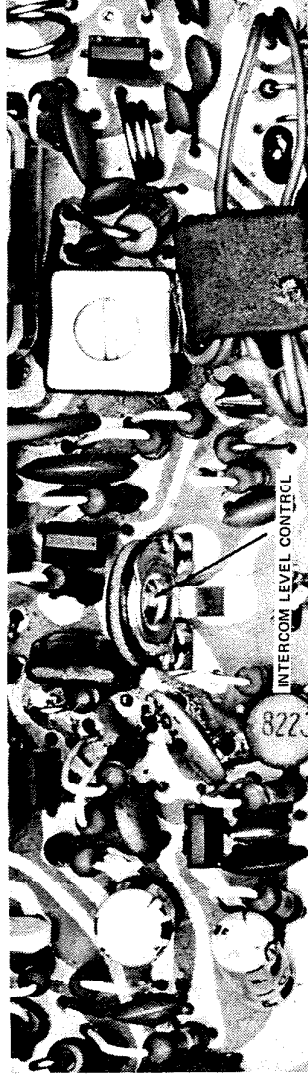

Master

1. Set Master Station VOLUME/ALL SPEAKERS control between 1/2 and 2/3 clockwise rotation.
2. Release Master Station as described in Paragraph 2 under "HOW TO REMOVE MASTER STATION FOR SERVICE." Tip Master Station forward to gain access to the Intercom PC board.
3. Using a small screwdriver, make only a slight adjustment of the Level Control counterclockwise. This will decrease the amount of Radio Volume relative to the Intercom Volume.
4. Check Intercom for improvement. Make further adjustment if necessary.
5. After making adjustments, push Master Station towards wall and replace Locking Pin.

## HELPFUL HINTS

1. If you do not want Radio Music but wish to leave the Intercom system functioning . . . set the Function Control to Auxiliary (AUX).
2. Be sure to leave VOLUME/ALL SPEAKERS control at a reasonably high level. This setting determines the maximum amount of sound available at any Remote Stations. However, if VOLUME/ALL SPEAKERS control is too high, and the Remote Stations VOLUME control are too low . . . distortion will result, and the Intercom operation will be impaired.
3. If squealing should develop on the Intercom, one of two things has probably occurred.
  - (a) The VOLUME/ALL SPEAKERS control is too high.
  - (b) Two or more speakers are located too close together. If this is the case, first reduce the VOLUME/ALL SPEAKERS control setting ; if this does not stop the squeal, reduce the Inside Speaker volume of one or both of the Speakers that are affecting one another.  
If trouble persists, it could be in the wiring, notify your installer.
4. If FM reception is not satisfactory, an external FM Antenna may help. We recommend that a NuTone Model IA-18 Antenna, or its equivalent, be installed on the roof or in the attic, pointed in the direction of the desired FM Stations. If FM stations are widely separated, an omnidirectional - type antenna may be required.
5. HOW TO CLEAN — If the surfaces of the Master or Remote Speakers should become finger-marked or dirty, they can be cleaned by wiping with a damp cloth.

## **FOR SERVICE OR SALES**

For the name of your nearest Authorized NuTone Service Center or Sales Outlet, residents of the contiguous United States should call, toll free, 800-543-8687 (in Ohio 800-582-2030) -- in Alaska, Hawaii, and all other locations outside the contiguous United States should write to: NuTone Division, Scovill Manufacturing Company, Madison and Red Bank Roads, Cincinnati, Ohio 45227 -- Attention: Department of Consumer Relations. In Canada write: NuTone Electrical, Limited, 2 St. Lawrence Avenue, Toronto, Ontario, Canada M8Z — 5T8 (or call 416-251-6580).

**NuTone Housing Products**

**Scovill**

Madison & Red Bank Roads, Cincinnati, Ohio 45227

Printed in U.S.A. 5/76  
Part No. 47531